

User Manual

TA74, TA74 IO

TA74 4G, TA74 4G T, TA74 4G IO

TA74_T_UM_EN_V3.1_2023.09

en User Manual



THIS PAGE IS LEFT INTENTIONALLY BLANK

Table of contents

1	Safety	6
1.1	Intended use	6
1.2	Improper use	6
1.3	User qualification	7
1.4	Warnings and symbols used	7
1.5	Safety instructions	7
2	Features	9
2.1	Product comparison	10
3	Scope of delivery	11
4	Product description	12
4.1	Device description	12
4.2	Emergency call button	12
4.3	Action button ("S" button)	13
4.3.1	Cancel emergency call	13
4.3.2	Take the first incoming call	13
4.3.3	Action button: Service Call	13
4.3.4	Action button: device status	13
4.4	Daily button	15
4.5	Sign in / sign out button	15
4.5.1	Sign out	15
4.5.2	Sign in	16
4.6	Device indications	16
4.6.1	Light signals	16
4.6.2	Local voice announcements from the device	18
4.6.3	Error messages	19
5	Installation	20
5.1	Installation recommendations	20

5.2	Installing the TA74	21
5.2.1	Placing on a surface	21
5.2.2	Wall mounting	21
5.3	Connecting the TA74	22
5.3.1	PSTN connection	22
5.3.2	External phone connection	23
5.3.3	Ethernet (LAN) connection	24
5.3.4	GSM (mobile network) connection	25
5.3.5	External GSM antenna connection	27
5.3.6	Internal input/output	28
5.3.7	Power connection	30
5.3.8	Performing a test	30
5.4	Switching off	31
6	Programming	32
6.1	Programming methods	32
6.2	Vocal reminders	32
6.3	Special button functions	33
6.3.1	Maintenance button	33
6.3.2	Resetting the TA74	33
6.3.3	Restoring the TA74 to default settings	33
6.3.4	Entering Service mode	34
6.3.5	Exiting Service mode	34
6.4	Transmitters registration	35
6.5	Wireless transmitter range test	36
6.6	Setting Dynamic Host Configuration Protocol (DHCP) and announcing IP address 37	
6.7	Audio volume	37
6.8	GSM signal level test	38
6.9	Call progress tones audible	39
6.10	Unpair the device	39
6.11	Activity monitors hours	39
7	Additional devices	40
7.1	Wireless transmitter	40

7.2	Installing wireless transmitter on necklace	41
7.3	Shortening the necklace cord	42
7.4	Wireless detectors	42
8	Operation	43
8.1	Emergency call to an alarm receiving centre	43
8.2	Emergency call to a landline telephone	43
8.3	Emergency call to a VoIP phone	44
8.4	Key functions on a landline telephone or a VoIP phone	44
8.5	Taking phone calls	45
8.6	Test instructions	46
8.6.1	Manual test emergency calls	46
8.6.2	Automatic test emergency calls	46
8.6.3	Automated control functions	46
9	Cleaning, disinfection, maintenance, reuse	48
9.1	Cleaning and disinfection	48
9.2	Maintenance	49
9.3	Reuse	49
9.4	Disposing of the device	50
9.5	Replacing the unit battery	51
9.6	Replacing the battery of the wireless transmitter	54
10	Appendix	55
10.1	TA74 technical specifications	55
10.2	Technical specifications of wireless transmitter	57
10.3	Certifications and approvals	58
10.4	Licences	59
10.5	Conformity	59

1 Safety

This user manual contains important information for safe installation and operation of the TA74 devices.

A proper installation and configuration of the TA74 is the basis for reliable communication between persons requiring assistance at home and an alarm receiving centre or other telephone connection.

A prerequisite for the error-free functioning of the device is that you have read and understood these instructions before using it.

If you require additional information about the TA74, please contact TeleAlarm or visit the website at www.telealarm.com.

1.1 Intended use

Intended use means that the TA74 may only be operated within the limits of its technical specifications and in conformity with the information given in these instructions. Any other use will be regarded as misuse and can result in malfunctions and damage.

The TA74 is used:

- as part of a carephone system to send emergency calls to an alarm receiving centre,
- or as a standalone device to send emergency calls to a private phone connection,
- for voice connections between the person who requires assistance and the call recipient,
- as an activity monitor,
- for automatic vocal reminders,
- to receive signals from external devices (e. g. mechanical pull switches) via the input/output connection (TA74 IO and TA74 4G IO only),
- to trigger external devices (e. g. door openers) via the input/output connection (TA74 IO and TA74 4G IO only).

The operator (operating company) is responsible for ensuring that the TA74 is used as intended. The operator must ensure that the operating staff fulfil all the required conditions for the installation and utilisation of the device.

1.2 Improper use

Improper use of the TA74 is any unauthorised and therefore non-permitted usage or modification of the hardware. The operator of the device bears sole responsibility for any damage resulting from this.

The TA74 must not be used:

- as a medical reminder,
- as an audio baby-monitor.

1.3 User qualification

For the configuration and parametrisation of the TA74, specific tool and device knowledge is required. These tasks may only be carried out by trained and authorised personnel.

The TA74 and the wireless transmitter must be serviced and repaired by an authorised service partner.

1.4 Warnings and symbols used

Depending on the hazard level, the warnings and notes used in this manual have the following meaning:



WARNING!

means that fatal or serious injury can occur if the described precautions are not taken.



NOTE

means that damage to the equipment or undesirable effects may occur if the described precautions are not taken.



INFO

General notes and additional information.

1.5 Safety instructions

Adhere to the following safety instructions to avoid personal injury, equipment damage and malfunctions:

- Do not install the device near a heating appliance.
- Do not expose the device to direct sunlight.
- Do not install the device in a wet or humid environment.
- Never touch the power adapter with wet hands.
- Do not attempt to open the device or the power adapter.
- When unplugging the device from the power outlet, never pull on the power cord but always grip the power adapter.
- Connect the TA74 only to a professionally installed 100 - 240 V AC, 50/60 Hz power outlet with a fuse up to 16 A near the TA74.
- Connect the power adapter to a power outlet near the TA74.

- Do not install the TA74 in the proximity of DECT/GSM telephones, TV sets, large metal objects, microwave appliances or radio telephones. This will impair the reception of signals from the wireless transmitter.
- Use only original cables and original power adapters. Other power adapters could damage the device. For replacement, use the same type of power supply as the one delivered with the product.
- Use the device only in the country where it has been delivered.
- Electrolytes or gases may be emitted from the battery should it leak under exceptional circumstances. If this happens, deactivate the device by isolating it from the network and power supply. Battery replacement must be carried out by trained service personnel only.
- Comply with your national regulations, guidelines and requirements for the disposal of end-of-life electrical equipment and batteries.
- Be sure to allow the required space around the device. The TA74 must be easily accessible.
- The wireless transmitter provided with the TA74 contains a button cell battery. If the button cell battery is swallowed, it can cause severe internal burns in just two hours and can lead to death. Keep new and used batteries out of the reach of children. If the battery compartment does not close securely, stop using the product and keep it out of the reach of children. If you think batteries might have been swallowed or placed inside any part of the body, seek immediate medical attention.

Electrostatic discharge



NOTE

The TA74 contains highly sensitive electronic components. It should be opened only in an ESD protected environment. Discharge electrostatic loads by touching a grounded conductive surface before you open the device.

2 Features



INFO

In this manual, "TA74" refers to the models TA74, TA74 IO, TA74, TA74 4G, TA74 4G T and TA74 4G IO.

The TA74 has been designed to ensure maximum security for persons living in their own homes or in locations where assistance could be needed. The device can be used to send emergency calls to an alarm receiving centre or a private phone, using different media and protocols.

The person requiring assistance activates a call by pressing a button on the TA74 or by using a wireless transmitter. This action establishes a voice connection between the person requiring assistance and the call recipient.

The device has two basic operating modes:

1. The TA74 is part of a carephone system that consists of an alarm receiving centre that can be reached at any time and the device itself. Calls are sent to this alarm receiving centre.
2. If the TA74 is operated as a standalone device, emergency calls will be sent to private phones.

The TA74 can be used with up to 20 wireless transmitters.

The TA74 is able to store up to 10 different recipients (telephone numbers or IP addresses). When an emergency call is sent and if the call to the first recipient is not successful, the TA74 will try the next one. If the final number has been dialled unsuccessfully, the device starts with the first recipient again and continues until it sends an emergency call successfully. A single programmed number will be tried 12 times. The maximum number of dial attempts is set to 15 attempts.

The TA74 offers other useful functions in addition to sending emergency calls. For example, support of activity monitoring (home/away, intrusion, personal staffing), support of intrusion and motion detectors and 'environmental' peripheral devices (smoke detectors, gas detectors, flood detectors, etc.), vocal reminders, or wired input/output connections.

**NOTE**

Program the internal date and time of the device to ensure that the activity monitoring and vocal reminders features function correctly.

To set the date and time, use the different programming methods described in chapter 6 "Programming".

This action is automatically done if the device is connected to the internet and registered in the TeleAlarm® Cloud Services.

**NOTE**

This device must be tested weekly. See section 8.6 "Test instructions".

2.1 Product comparison

	TA74	TA74 IO	TA74 4G	TA74 4G T	TA74 4G IO
Multiple protocols	✓	✓	✓	✓	✓
Recordable voice message	✓	✓	✓	✓	✓
PSTN connection	✓	✓	✗	✓	✗
Ethernet (LAN) connection	✓	✓	✓	✓	✓
External phone connection	✓	(✓)*	✗	✓	✗
Extended management of alarm types	✓	✓	✓	✓	✓
Energy saving mode	✓	✓	✓	✓	✓
Vocal reminders	✓	✓	✓	✓	✓
Activity monitoring	✓	✓	✓	✓	✓
Embedded GSM module	✗	✗	✓	✓	✓
Voice call initiation by alarm receiving centre via GSM	✗	✗	✓	✓	✓
Internal input/output	✗	✓	✗	✗	✓
Max. number of wireless transmitters and detectors	20	20	20	20	20
Programmable call destinations	10	10	10	10	10

*) Only possible with a special external splitter (see also section 5.3.6 "Internal input/output")

3 Scope of delivery

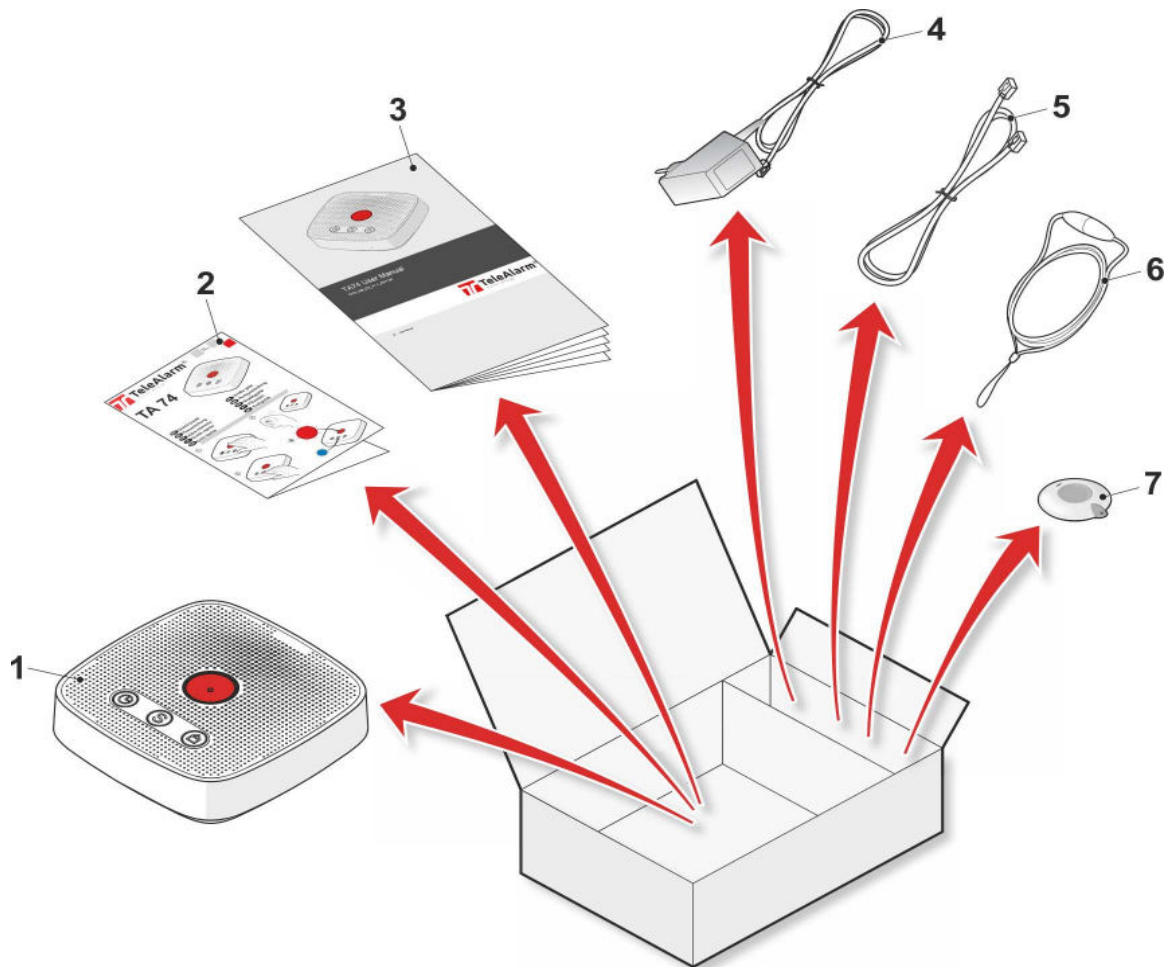

1. TA74 including pre-installed, rechargeable unit battery
2. Quick Guide for users
3. Optional manual for technicians/installers
4. Power adapter
5. Optional telephone cable and/or network connection cable
6. Necklace or bracelet
7. Wireless transmitter (battery included)

Additional accessories can be supplied on request.



WARNING!

To reduce the risk of fire and electric shock, always replace damaged components and parts with identical ones.



INFO

You can find user manuals and complete documentation for the devices at:
www.telealarm.com

4 Product description

4.1 Device description

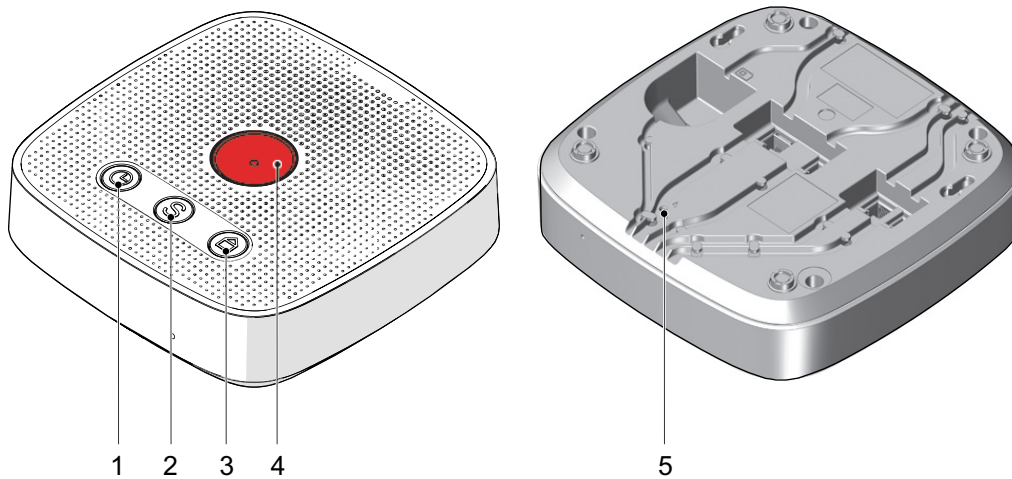

1. Daily button
2. Action button
3. Sign in / sign out button
4. Emergency call button
5. Maintenance button

4.2 Emergency call button

If you require help, press the **Emergency call button** to initiate a call.

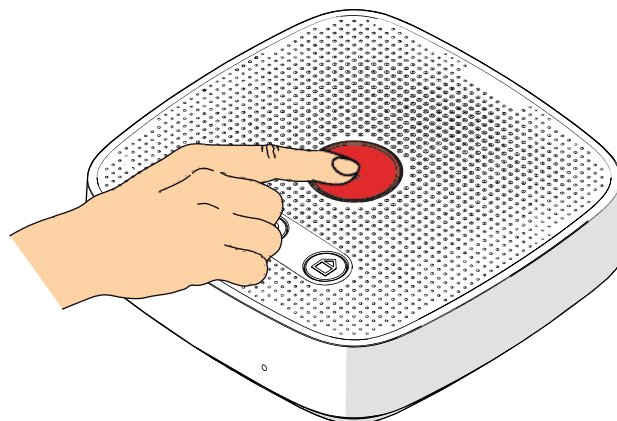

The call will be answered either by a person at the alarm receiving centre, a relative or other individual, according to the programmed destination.

4.3 Action button ("S" button)

4.3.1 Cancel emergency call

If you have pressed the **Emergency call button** by mistake, you can cancel the call with the **Action button** during the pre-alarm time.

Press the **Action button** until the device announces <Stop>. Emergency calls cannot be cancelled after the pre-alarm time.

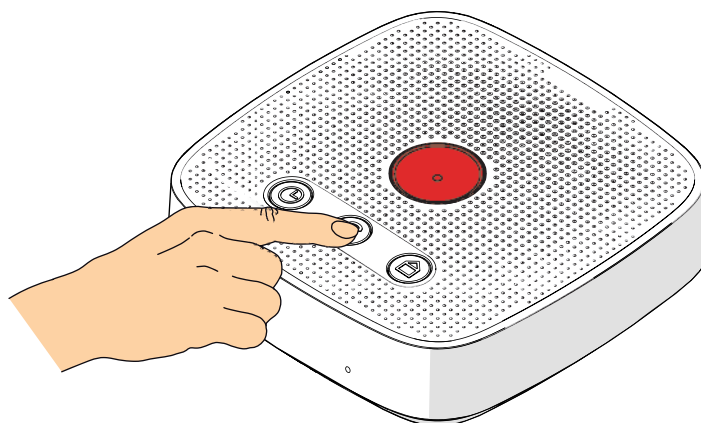

4.3.2 Take the first incoming call

If your TA74 is delivered to you unprogrammed, this special function allows you to accept the first incoming call (PSTN connection only).

► Press the **Action button** 3 times within 3 seconds.

If the first incoming call is from your alarm receiving centre that supports this functionality, the operator can start a remote programming session. For more information, see the *Reference Manual*.

4.3.3 Action button: Service Call

The **Action button** can also be used to initiate a Service Call. If you press the **Action button** and hold it for at least 2 seconds, the unit dials a call number that has been programmed for the Service Call and you will hear the announcement <Service Call>.

4.3.4 Action button: device status

If there is a malfunction, the **Action button** flashes.

Press the **Action button** to hear an announcement of the detected problem.



INFO

In the event that a low battery status or supervision issue is detected on any registered wireless transmitter, the Action button will not flash as an indication. However, when you press the Action button, the system will audibly announce the issue associated with the wireless transmitter. This feature enables you to promptly identify and address any low battery or supervision problems with the transmitter.

4.4 Daily button

The TA74 has a built-in activity monitor, which ensures that an emergency call is made automatically if the **Daily button** is not pressed within a preset period of time. The light on the **Daily button** lights up when it should be pressed.

The activity monitor can also be reset by a wireless transmitter. The **Daily button** is also used for presence marking by staff:

- ▶ Press the Daily button for two seconds upon arrival
- ▶ Press the Daily button for a short time upon departure

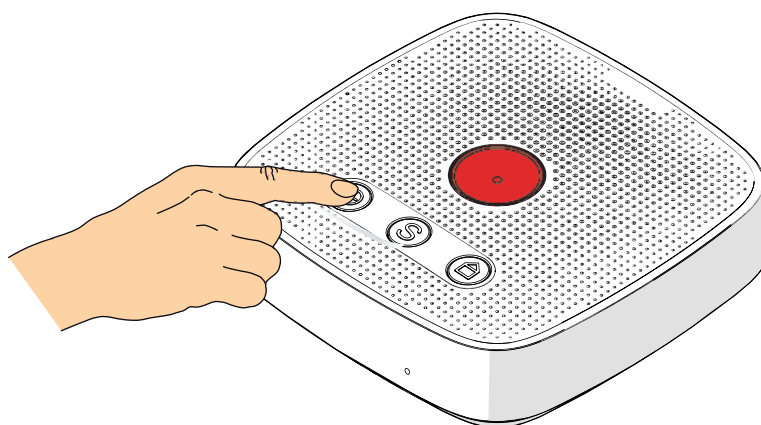

4.5 Sign in / sign out button

Pressing the **Sign in / sign out button** tells the device whether you are currently at home or not.

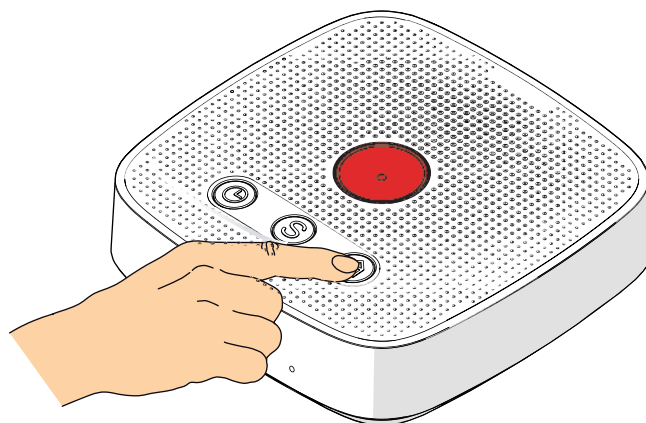

4.5.1 Sign out

When you leave home, press the **Sign in / sign out button**. You will hear the announcement <Sign out>. The activity monitor is temporarily disabled.

4.5.2 Sign in

When you return home, press the **Sign in / sign out button** again. You will hear the announcement <Sign in>.







INFO













Calls can be made via the **Emergency call button** or a wireless transmitter at any time, even after a sign out. This signs you in.







4.6 Device indications











4.6.1 Light signals

The TA74 has four indicator lamps that display the status of the device. The symbols have the following meanings:

	Lamp shines bright
	Lamp shines dull
	Lamp flashes (0.5 s)
	Lamp flashes twice (0.5 s)
	Lamp flashes quickly (0.1 s)

Status	Description or action	Blue	Red
Initialisation	After power on		
Device not programmed	The device will beep 5 times in succession every 10 seconds, and the LEDs will flash alternately.		
Error	Error message is announced once. Press the Action button to repeat the error message. See section 4.6.3		
Standby, normal mode	The device is in standby.		
Standby, battery-operated			
Standby mode with the Action button set as service button			
Pre-alarm	Can be cancelled with the Action button		
Connection	Connection established		

Status	Description or action	Blue	Red
Speak	Speak (indication for the hearing impaired)		
Listen	Listen (indication for the hearing impaired)		
Repeated call	When a call is repeated		
Call activated	If the call is not acknowledged, a new call will be sent.		
Call back waiting time	Pressing the Action button acknowledges the alarm.		

Status	Description or action	Yellow	Green
Initialisation	After power on		
Signed out, normal mode	The Sign in / sign out button has been pressed. The activity monitor is inactive.		
Signed out, battery operation			
Signed in, normal mode	The activity monitor is active. Press the Daily button every day.		
Signed in, battery operation			
Active time frame, normal mode	Press the Daily button now		
Active time frame, battery operation			
Pre-alarm activity monitor	Cancel with the Daily button		
Sign in by staff			

4.6.2 Local voice announcements from the device

Voice announcement	Meaning
<Emergency call>	When the Emergency call button is pressed
<Call activated>	Connection failed - device is calling again
<Stop>	The emergency call was cancelled by pressing the Action button during the pre-alarm time.
<Service call>	When the Action button is pressed, if it is programmed as a service button
<Emergency call cleared>	When a repeated call is acknowledged on the device
<Call ended>	When a callback is acknowledged on the device
<Radio button [x]>	When a wireless transmitter button is pressed, x being the number of the transmitter, from 1 to 10
<Sign in>	When the Sign in / sign out button is pressed
<Sign out>	When the Sign in / sign out button is pressed
<Activity monitor, press yellow button please>	Message before the activity monitor expires. Press the Daily button to reset.
<Activity monitor reset>	When the Daily button is pressed before the end of the time frame
<Activity monitor expired>	When an activity monitor alarm is sent
<Alarm input>	When the external input is activated (TA74 IO and TA74 4G IO only)

4.6.3 Error messages

Error messages are announced by the TA74 locally and/or by the telephone in phone protocols. When synthetic speech mode is disabled, error messages are only announced by beeps.

Voice announcement	Media	"Synthetic speech disabled" mode	Meaning and action needed
<Power failure>	Local & phone	1 beep	Main power supply failure. Check the power connection.
<Power restored>	Phone	–	Main power supply restored
<Line failure>	Local & phone	2 beeps	Connection to PSTN or IP network has been lost. Check the connection.
<Unit battery empty>	Local & phone	3 beeps	The unit battery is empty. Connect the device to the main power supply.
<Transmission failure>	Local	4 beeps	Emergency call not sent. Contact the alarm receiving centre.
–	Local	5 beeps	Device is not operational. For more information, see the <i>Reference Manual</i> .
<Failure zero-one>	Phone	4 beeps	Radio frequency jamming. Another wireless transmitter is disrupting the radio signal.
<Failure two [x]>	Phone	3 beeps	Wireless transmitter [x] battery empty. Replace the wireless transmitter battery.
<Failure three [x]>	Phone	4 beeps	Wireless transmitter [x] radio transmission failure. Check the wireless transmitter.
<Radio button [x] battery empty>	Local	–	Wireless transmitter [x] battery empty. Replace the wireless transmitter battery.
<Radio button [x] Error>	Local	–	Wireless transmitter [x] missing supervision. Ensure that the transmitter location is at an adequate radio range and replace the wireless transmitter battery if needed.

5 Installation



INFO

Before starting to install and program the TA74, please read the safety instructions in chapter 1 "Safety" and the following recommendations carefully.

5.1 Installation recommendations

- Place the TA74 on a flat and non-slip surface.
- Do not cover the microphone (right-front side of the device) and the loudspeaker (top of the device).
- The TA74 must be connected to the original power adapter.
- To send an alarm, at least one alarm receiver (an alarm receiving centre or a private phone) must be programmed.
- The power adapter of the TA74 must be at least 10 cm away from the device.
- The power adapter must be plugged into a wall socket in the proximity of the TA74 and must remain easily accessible at all times.
- Construction materials affect the range of the device. For example, reinforced concrete walls hamper the radio signal more than a brick wall.
- The location of the TA74 affects the range of the wireless transmitter. The best place to locate it is a central room.
- To optimise battery lifetime, place the TA74 4G, TA74 4G T or TA74 4G IO in a location where the GSM signal level is as good as possible. In the case of a very weak GSM signal, the battery lifetime could be reduced.



NOTE

If several media LAN, GSM, PSTN are used during the alarm call sequence, several paths are used to transmit the alarm. The use of a combination of transmission methods therefore increases the reliability of alarm transmission.

As technology advances and competition for bandwidth capacity increases, telephone providers are switching all voice telephony transmissions to compressed digital transmission methods. This technological changeover from an analogue to a digital environment leads to problems. Alarm transmission with analogue protocols becomes difficult and unreliable.

For this reason, TeleAlarm strongly recommends the use of digital protocols such as EN 50134-9, RBIP-S, SCAIP or RBIP in order to ensure reliable alarm transmission.

The best way to ensure alarm transmission to the alarm receiving centre is to combine communication paths (e.g. LAN and GSM) and protocol types, ideally digital protocols, within the alarm call sequence of the device.

5.2 Installing the TA74

5.2.1 Placing on a surface

The TA74 is designed for use at home. Many items of furniture are coated with a variety of paints, varnishes and plastics. The feet of the TA74 may leave marks on furniture as a result of chemical processes.

5.2.2 Wall mounting

You can mount the TA74 directly onto a wall. You will need two screws with a shank diameter of less than 5 mm and a head diameter between 7 and 9 mm, and two suitable wall plugs.

1. Position the plugs and screws so that the distance between the screw centres measures 152 mm: see the drawing below.
2. Locate the holes for the screws on the back of the device.
3. Adjust the screw depth.



INFO

If the device is mounted on the wall, the cables can be fed through the cable channels and through the opening on the front of the unit.

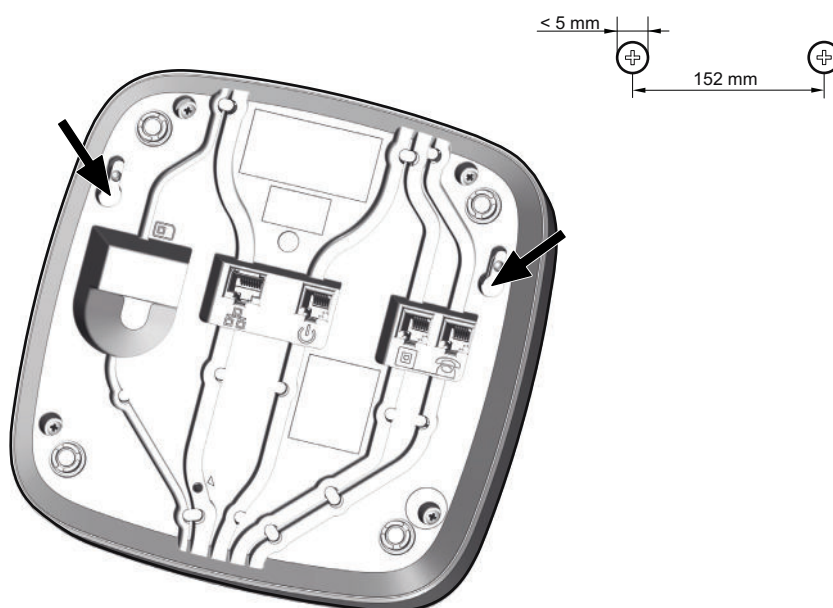

5.3 Connecting the TA74

5.3.1 PSTN connection

(all models except TA74 4G, TA74 4G T and TA74 4G IO)

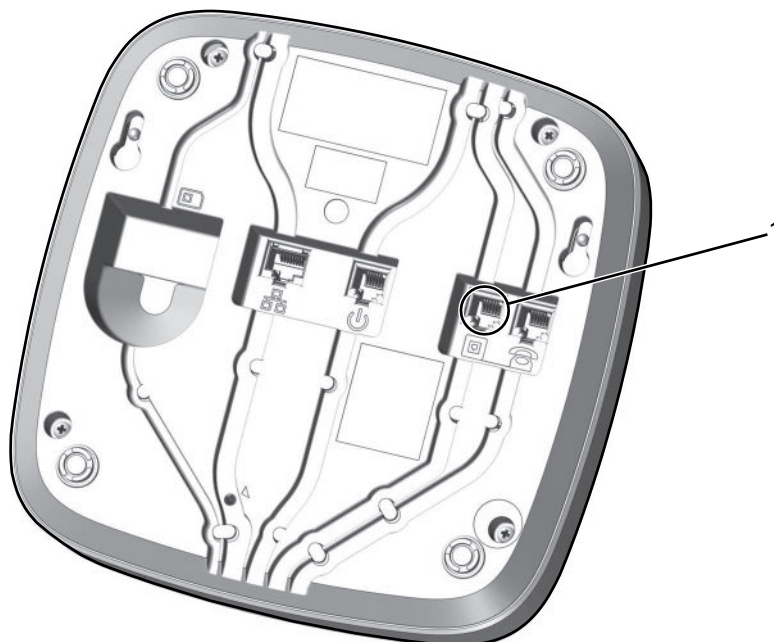

1. Insert the plug of the telephone cable into the corresponding socket **(1)** on the TA74. Feed the cable through the cable channel and through the opening on the back of the device.
2. Fit the plug of the telephone cable into the socket of the telephone outlet.



NOTE

Only connect the device to a telephone outlet that has been correctly installed by your telephone service provider. The TA74 is designed to be connected to the public telephone network.

5.3.2 External phone connection

(TA74 and TA74 4G T only)

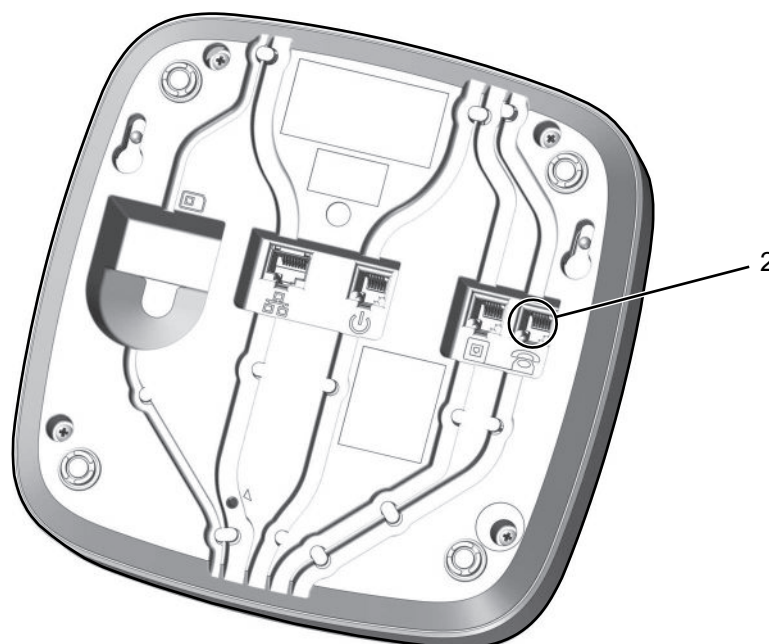

1. Insert the plug of the external telephone cable into the corresponding socket **(2)** on the TA74. Feed the cable through the cable channel and through the opening on the back of the device.
2. Fit the other end of the external telephone cable into your telephone.



WARNING!

Risk to the person in need of assistance as a result of failed emergency calls. In the event of an emergency, the device must be able to send out an emergency call even if a phone call is in progress at the time.

To check whether an emergency call can be sent:

1. Make a phone call as you normally would.
 2. When the phone call is in progress, press the **Emergency call button**.
- If the setup is correct, the phone call will be interrupted immediately after the pre-alarm.



WARNING!

Risk to the person in need of assistance as a result of failed emergency calls. With a private branch exchange (PABX or a digital box), there is no guarantee that a phone call will be interrupted by the emergency call.

5.3.3 Ethernet (LAN) connection

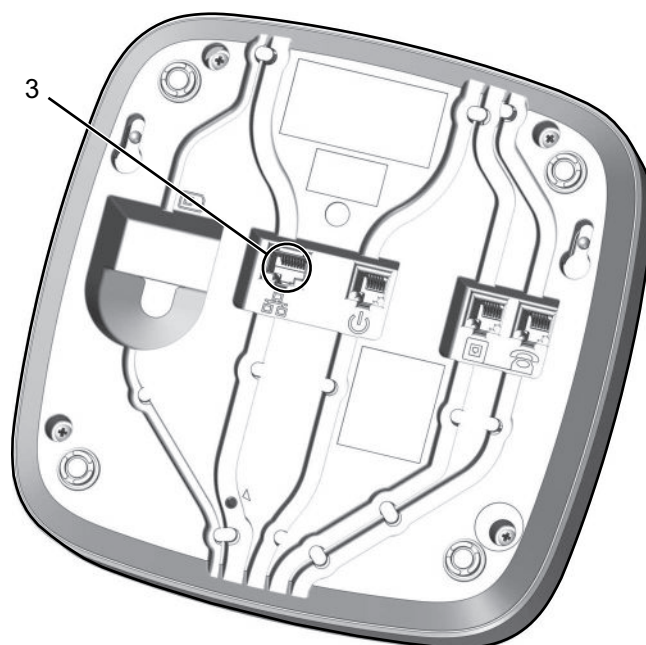

1. Insert the plug of the network connection cable into the corresponding socket **(3)** on the TA74. Feed the cable through the cable channel and through the opening on the back of the device.
2. Depending on your installation configuration, fit the other end of the network connection cable into your router outlet or switch.

**NOTE**

Be aware of potential limitations due to network availability. In the case of DSL or cable connections, be aware of the potential effects of power failures. Prioritising an emergency call may not always be possible.

**NOTE**

The TA74 should only be connected to a device with the autonegotiation procedure enabled for Ethernet communication.

**NOTE**

Use only the original flat LAN cable supplied by TeleAlarm.

5.3.4 GSM (mobile network) connection

(all models except TA74 and TA74 IO)

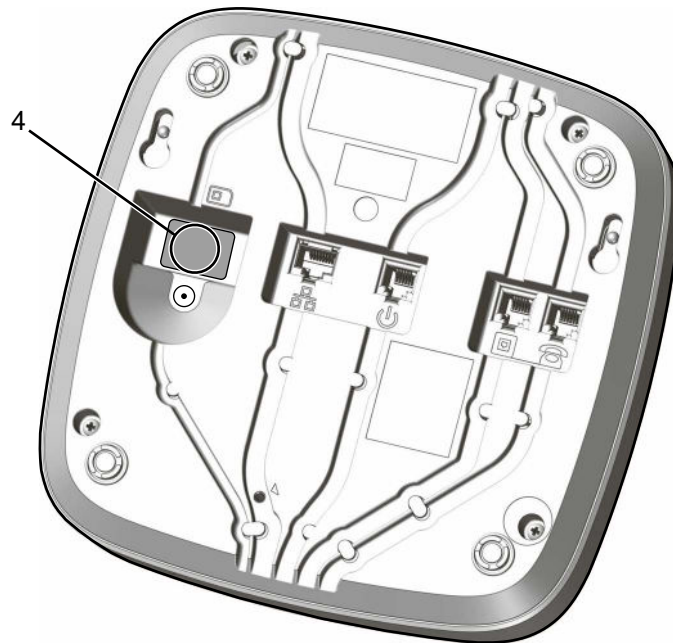

1. Remove the cover over the SIM card slot (**4**).
2. Open the metal clamp of the SIM card slot by sliding it to the left, and then lift the clamp up.
3. Insert a micro-SIM card (external dimensions 15 mm × 12 mm) into the SIM card slot. The cut-off corner must be located on the top right. The contacts must face downwards.
4. Close the metal clamp by pressing gently on the SIM card, then slide it to the right until it locks in position.
5. Replace the cover.

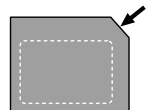

NOTE

With a GSM connection, we strongly recommend using the EN 50134-9, RBIP-S, SCAIP or RBIP protocol. Please refer to the *Reference Manual* for more information on programming. Other protocols are accepted, but they will be transmitted through the GSM voice band.

The quality of the communication depends on the chosen protocol, the GSM signal level and the service provider.



NOTE

Be aware of potential limitations due to network availability. Prioritising an emergency call may not always be possible.

**NOTE**

Check the duration and conditions of the SIM card contract. Make sure the SIM card contract has no restrictions with regard to data connection, voice connection, credit or connection time. Do not use pre-paid contracts for these devices.

5.3.5 External GSM antenna connection

(all models except TA74 and TA74 IO)

The TA74 4G, TA74 4G T and TA74 4G IO are equipped with an internal GSM antenna. If required, an external antenna can be connected.



NOTE

Connect only an original TeleAlarm antenna which is compatible with the TA74 model intended to be connected, as otherwise, the functionality is not ensured.

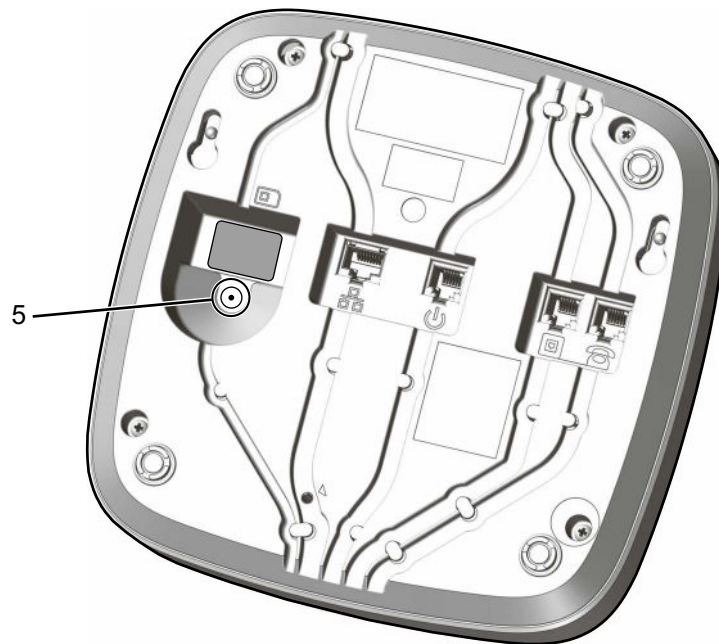

1. Remove the power plug from the socket (6); see figure in section 5.3.7 "Power connection".



NOTE

The internal date and time are erased and must be set again after reconnection. This action is automatically done if the device is connected to the internet and registered in the TeleAlarm® Cloud Services.

2. Connect the antenna to socket (5). Feed the cable through the cable channel and through the opening on the back of the device.



NOTE

Place the antenna at least one metre from the TA74. The antenna can be fixed in position with the magnetic holder, with screws or with the integrated adhesive tape.

3. Reconnect the TA74 to the power supply.
 - ▶ The device will be restarted, and the antenna is activated automatically.

5.3.6 Internal input/output (TA74 IO and TA74 4G IO only)

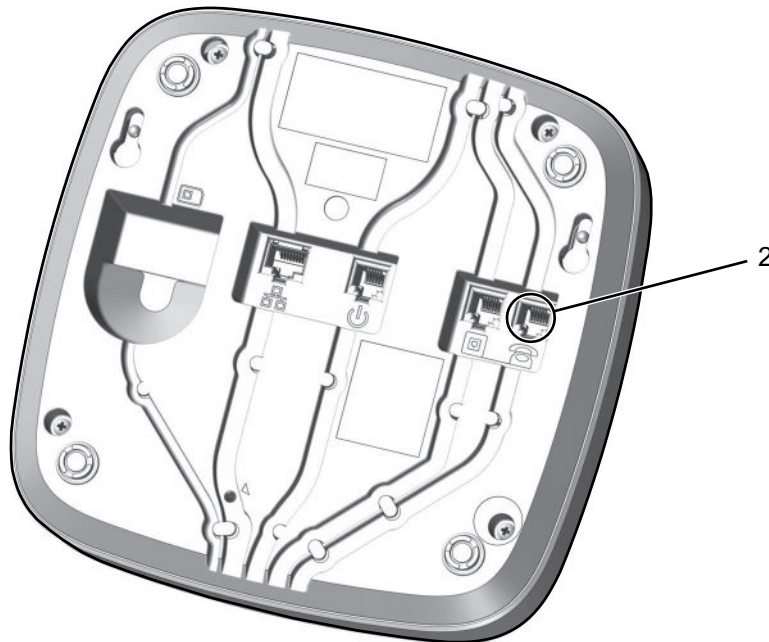

Use the socket of the external telephone **(2)** for the internal input/output.



INFO

You cannot connect an external telephone to socket **(2)**.

However on the TA74 IO and TA74 4G IO, it is possible to connect an external telephone to the PSTN connector together with the phone line, using a special splitter. The splitter can be ordered from TeleAlarm.

1. Remove the power plug from the socket **(6)**; see figure in section 5.3.7 "*Power connection*".



NOTE

The internal date and time are erased and must be set again after reconnection.

2. Connect the external device to the I/O cable.
3. Insert the plug of the I/O cable into the corresponding socket **(2)** on the TA74. Feed the cable through the cable channel and through the opening on the back of the device.

Connector pin assignment

The relay output and an external device are connected using a cable with an RJ12 plug.

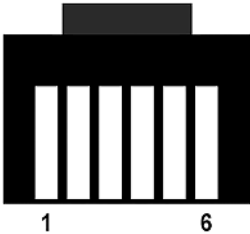
Pin view	RJ12 plug	Function
	Pin 1	External input
	Pin 2	Relay output NO (normally open)
	Pin 5	Relay output C (common)
	Pin 6	External input GND

The device is equipped with one isolated, normally open relay contact (1 A, 30 V DC, 0.3 A, 30 V RMS) and one potential-free input.

The external input is pulled by a resistor (Pin 1).

A switch or an external relay can be used to connect the input signal to ground (Pin 6).

5.3.7 Power connection

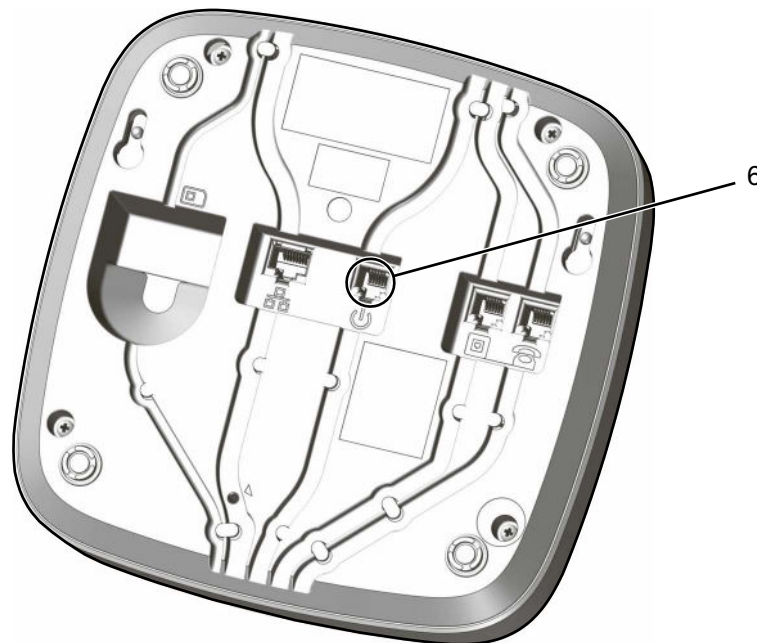

1. Insert the plug of the power adapter into the corresponding socket **(6)** on the TA74. Feed the cable through the cable channel and through the opening on the back of the device.
2. Plug the power adapter into the power outlet.

All indicator lamps will light up for approx. two seconds. (This is a battery test.) The device switches to standby mode and can now be programmed. For more information, see the *Reference Manual*.



INFO

The unit battery will charge up when the TA74 is connected to the main power supply. The specified standby time is available when the battery is fully charged, after approx. 16 hours.

If the device is disconnected and stored, connect it to the main power supply at least once every 6 months to allow the battery to charge.

5.3.8 Performing a test

Once the device is installed and programmed, perform a test immediately by triggering an alarm with the wireless transmitter. See also section 8.6 "Test instructions".

5.4 Switching off

To switch the TA74 off without battery operation, remove the plug of the power adapter from the corresponding socket **(6)**.



NOTE

The internal date and time are erased and must be set again after reconnection.



INFO

If you remove the power adapter from your power outlet, the unit announces '**power failure**'. The device will then automatically switch to battery operation.

6 Programming

Before you program the TA74, you must be familiar with all of the device's functions. Programming may only be carried out by trained and authorised personnel.



NOTE

Correct programming of the TA74 is essential to ensure the full functionality of the device. When the device is put into operation for the first time, the red and blue LEDs will flash alternately, and the device will emit five beeps every 30 seconds. This warning signal indicates the need for initial programming of the device. Please refer to the *Reference Manual* for more information on programming.

6.1 Programming methods

Three programming methods are available:

- via TeleAlarm® Cloud Services
- via the Configuration Manager software
- via a compatible alarm receiving centre

Please refer to the corresponding documents for more information.



INFO

Check the remote programming possibilities with your alarm receiving centre.

6.2 Vocal reminders

Three reminder messages can be recorded. Each notification can be automatically played on a configured day and at a configured time. It is repeated every 20 seconds until the **Daily button** is pressed or the preset time has elapsed. If the reminder message is not acknowledged, the device can send an alert to the alarm receiving centre.

Please refer to the *Reference Manual* and the *Configuration Manager Manual* for more information on programming.

6.3 Special button functions

6.3.1 Maintenance button

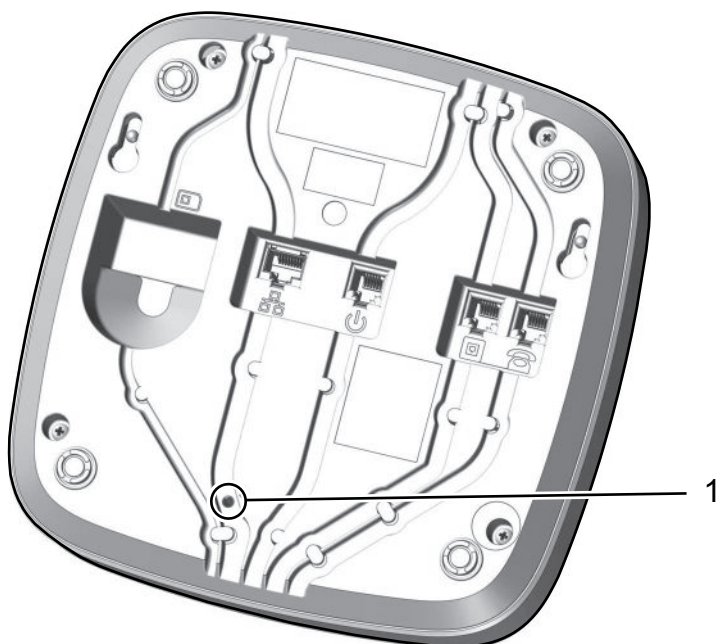

To press the **Maintenance button (1)**, use something long and thin, such as an unfolded paper clip.

6.3.2 Resetting the TA74

1. Press the **Maintenance button** for 0.5 to 2 seconds and then release it.
2. The device beeps and reboots.

6.3.3 Restoring the TA74 to default settings

1. Press the **Maintenance button** for at least 20 seconds.
2. The device announces <Setup reset>.

The device is now non-operational; it has to be reprogrammed via the Configuration Manager or the platform TeleAlarm[®] Cloud Services. Please refer to the *Reference Manual* for more information on programming.



NOTE

This function deletes all user settings and restores the default settings.

6.3.4 Entering Service mode



INFO

It is only possible to enter Service mode when the device is on standby (no active emergency call).

1. Press simultaneously the yellow and the green buttons for 2 seconds or press the **Maintenance button** for about 6 seconds to enter Service mode.
 - ▶ Voice messages in English guide the user in order to make easy settings selection.
2. Use the **Action button** to navigate the menu.
3. When the desired function is announced, press the **Emergency call button** to access it.

Service mode functions:

Function	Description
Function 1	Transmitters registration. See section 6.4, Page 35.
Function 2	Wireless transmitter range test. See section 6.5, Page 36.
Function 3	Set Dynamic Host Configuration Protocol (DHCP) mode and announce IP address. See section 6.6, Page 37.
Function 4	Set audio volume. See section 6.7, Page 37.
Function 5	GSM signal level test. See Section 6.8, Page 38.
Function 6	Call progress tones audible. See Section 6.9, Page 39.
Function 7	Unpair the device. See Section 6.10, Page 39.
Function 8	Activity monitors hours. See Section 6.11, Page 39.



INFO

To use function 2, the wireless transmitter must already be registered in the TA74.

6.3.5 Exiting Service mode

The TA74 automatically exits Service mode after performing function 1, 3, 4, 6, 7, 8. Press any button on the TA74 to exit function 2 or 5.

**INFO**

If no button is pressed for ten seconds, the TA74 will automatically exit Service mode.

6.4 Transmitters registration

This function allows the registration of a wireless transmitter to the TA74 (without using any software).

**INFO**

The wireless transmitter which is delivered with the TA74 is already paired.

Assigning a wireless transmitter to the TA74

1. Enter the **Service mode** and use function 1.
 - ▶ If necessary, see section 6.3.4 "Entering Service mode", page 34.
2. Select the function "Transmitters registration".
 - ▶ It is possible to assign up to twenty wireless transmitters to the TA74.
3. Press the **Emergency call button** to confirm the function selection.
4. Use the **Action button** to select the transmitter number to be assigned.
5. Press the **Emergency call button** to confirm the selection.
 - ▶ If the number is already assigned to a transmitter, the TA74 announces the registered radio code. Press the **Emergency call button** to confirm you want to overwrite the current transmitter and register the new one instead or wait a few seconds to exit the menu.
6. Press the wireless transmitter button to register the device with the TA74.
7. Press the wireless transmitter button a second time to confirm the pairing between the two devices.
 - ▶ After having performed the pairing, the TA74 automatically exits Service mode.

6.5 Wireless transmitter range test

It is possible to switch the TA74 to test mode in order to test the radio range of the wireless transmitter. If you press the wireless transmitter button, the TA74 announces the registration number where the wireless transmitter is assigned. No emergency call is initiated during this specific test period.



INFO

In order to test the wireless transmitter range, it must first be registered in the TA74.



INFO

If no number is announced the TA74 when the wireless transmitter button is pressed, it means that the transmitter is out of range or something is blocking the transmission.



INFO

The radio sensitivity is slightly decreased during this test.

Calling up and using the wireless transmitter range test

1. Enter the **Service mode** and use function 2.
 - ▶ If necessary, see section 6.3.4 "Entering Service mode", page 34.
 - ▶ When you access the wireless transmitter range test, a 3-minute timer starts. The device will automatically terminate the wireless transmitter range test at the end of the 3 minutes.
 - ▶ The red indicator lamp flashes every 2 seconds and the TA74 emits a short beep every 5 seconds to indicate that test mode is enabled.
2. Press the button on the wireless transmitter.
 - ▶ When the TA74 receives the signal from a registered wireless transmitter, it announces its registration number.
3. Press any button on the TA74 to exit the test mode.



INFO

Every time the TA74 receives a signal from a registered wireless transmitter, the 3-minute timer will be reset.

If no signal is received during 3 minutes, the TA74 will automatically return to standby mode.

6.6 Setting Dynamic Host Configuration Protocol (DHCP) and announcing IP address

If function 3 is selected, it will announce the Dynamic Host Configuration Protocol (DHCP) and the IP status.

The DHCP status (ON or OFF) and the IP address of the device are announced.

The DHCP status can then be set (disabled or enabled).

Switching DHCP on/off

1. Enter the **Service mode** and use function 3.
 - ▶ If necessary, see section 6.3.4 "Entering Service mode", page 34.
 - ▶ The TA74 will automatically announce the DHCP status and its IP address.
2. Press the **Emergency call button** to switch DHCP on/off.
 - ▶ After changing the DHCP mode, the TA74 exits Service mode automatically.



INFO

If the DHCP is disabled, the device will have a static IP address. For more information, see the *Reference Manual*. The default address is 192.168.1.10.

6.7 Audio volume

This function allows setting the default value of the audio volume.

1. Enter the **Service mode** and use function 4.
 - ▶ If necessary, see section 6.3.4 "Entering Service mode", page 34.
2. Select the appropriate audio volume using the **Action button**.
3. Press the Emergency call button to confirm the selection.

6.8 GSM signal level test

(TA74 GSM, TA74 GSM IO, TA74 4G and TA74 4G IO only)



INFO

The GSM signal level test mode is only available:

- if the micro-SIM card is correctly inserted in the TA74,
- if the GSM module is configured (SIM card PIN code, provider APN, etc.).

Repeat the test every time the device is moved to a new location.

This test mode will announce a number between 0 and 5 corresponding to the GSM signal level. The message is repeated every 3 seconds.

If an error is sent back, or if the GSM module does not answer, only a beep will be emitted from the device.

The announcements of the GSM signal level correspond to the following signal levels:

Announcement	Signal level in decibel-milliwatts (dBm)
<0>	≤ -112 dBm
<1>	-111 dBm to -98 dBm
<2>	-97 dBm to -84 dBm
<3>	-83 dBm to -68 dBm
<4>	-67 dBm to -54 dBm
<5>	≥ -53 dBm



NOTE

A signal level of at least <1> (-111 dBm to -98 dBm) is required to ensure correct use.

Entering and using GSM signal level test mode

1. Enter the **Service mode** and use function 5.
 - ▶ If necessary, see section 6.3.4 "Entering Service mode", page 34.
 - ▶ When you enter GSM signal level test mode, a 3-minute timer starts. The device will automatically exit GSM signal level test mode at the end of the 3 minutes.
 - ▶ The red indicator lamp flashes every 2 seconds and the device announces the GSM signal level every 3 seconds.
2. Press any button on the TA74 to exit the test mode.

6.9 Call progress tones audible

This function toggles the call progress tone audible parameter of the TA74 when the **Emergency call button** is pressed. For more information, see the *Reference Manual*.

To set the "call progress tones" function:

1. Enter the **Service mode** and use function 6.
 - ▶ If necessary, see section 6.3.4 "Entering Service mode", page 34.
2. Press the **Emergency call button** to change the status of the "call progress tones" parameter.
 - ▶ After performing the change, the TA74 announces the new status (ON or OFF) and exits **Service mode** automatically.

6.10 Unpair the device

The TA74 will release the last pairing (e.g. with a TA70 Audio Extender).

1. Enter the **Service mode** and use function 7.
 - ▶ If necessary, see section 6.3.4 "Entering Service mode", page 34.

6.11 Activity monitors hours

This function allows setting the time value in hours for the activity monitor. Setting "0" deactivates the activity monitor.

1. Enter the Service mode and use function 8.
 - ▶ If necessary, see section 6.3.4 "Entering Service mode", page 34
2. Use the Action button to select the time value to be assigned.
3. Press the Emergency call button to confirm the selection

7 Additional devices

7.1 Wireless transmitter

The wireless transmitter that is supplied with the TA74 allows you to trigger emergency calls from any place in your home within radio range.



Always keep the wireless transmitter on your person at home, especially if you are in the bathroom or sanitary area.



NOTE

The wireless transmitter is protected to the IP67 category. That means: The device is dust-tight and protected against temporary submersion (up to 30 minutes at a maximum depth of 1 metre).

To make an emergency call using the wireless transmitter:

1. Press the button on the wireless transmitter.
 - ▶ The indicator lamp lights up once as confirmation.
 - ▶ The TA74 announces <Radio button x> (x is the number of the wireless transmitter) and the call sequence starts.

An emergency call made by mistake can be cancelled during the pre-alarm by pressing the **Action** button on the TA74.



WARNING!

Risk to the person in need of assistance as a result of failed emergency calls.

The radio range between the wireless transmitter and the TA74 depends largely on the environment in which the devices are used. Test the range of the wireless transmitter within your entire home area.

Within buildings, a maximum range of 30 to 50 meters is achieved, or up to 300 meters in the open air.

7.2 Installing wireless transmitter on necklace

1. Insert the thin wire in the hole of the ring.
2. Pass the necklace cord through the loop formed by the thin wire.
3. Pull the necklace cord until the thin wire is passed around the ring.

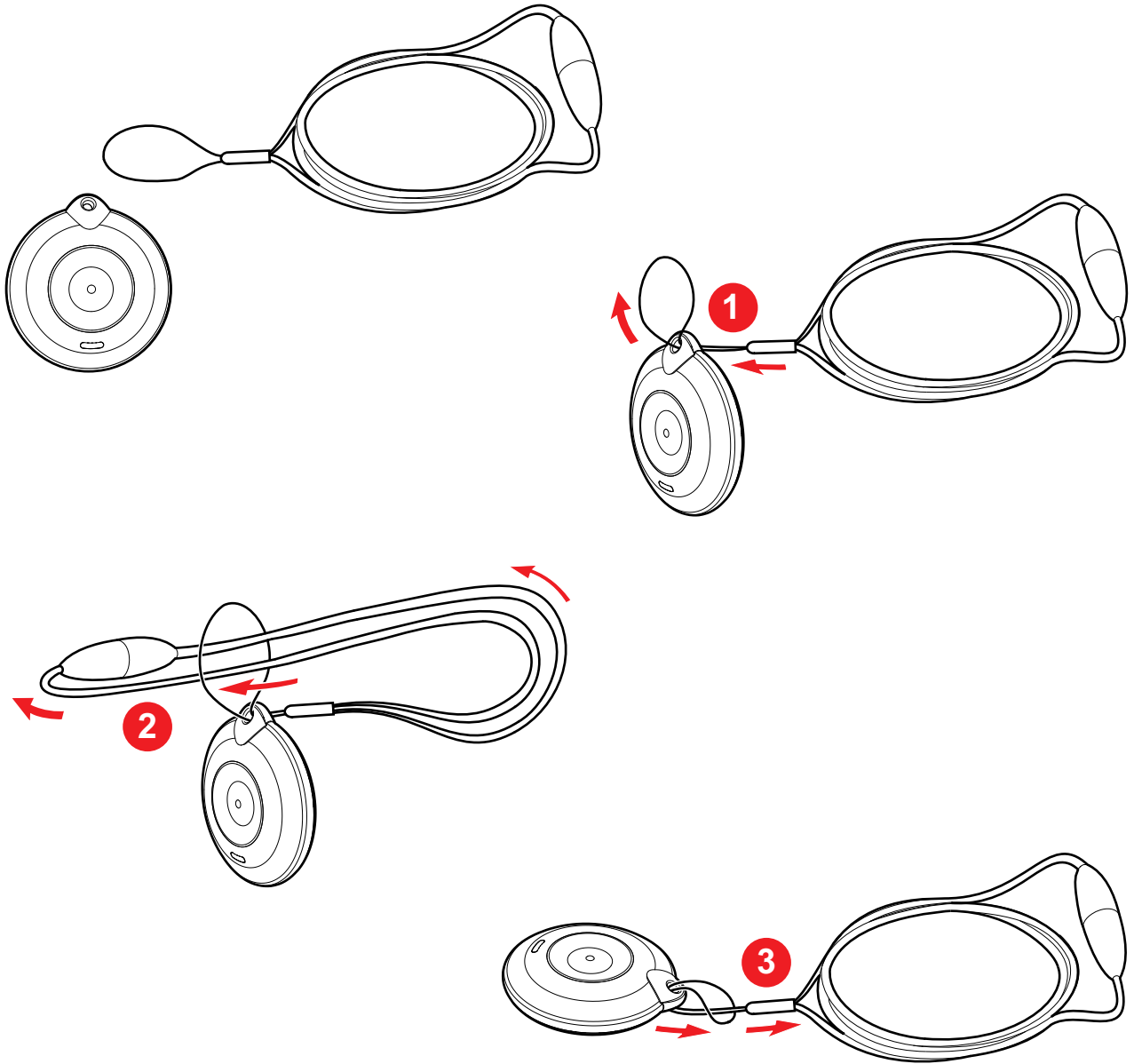

7.3 Shortening the necklace cord

1. Open the necklace cord with the two connectors.
2. Push the female connector back to the beginning of the cord.
3. On the cord of the female connector, make a knot at your preferred length.
4. Using scissors, cut the excess cord after the knot.
5. Push the female connector over the knot and close the two connectors.



NOTE

Do not tie knots in the cord.

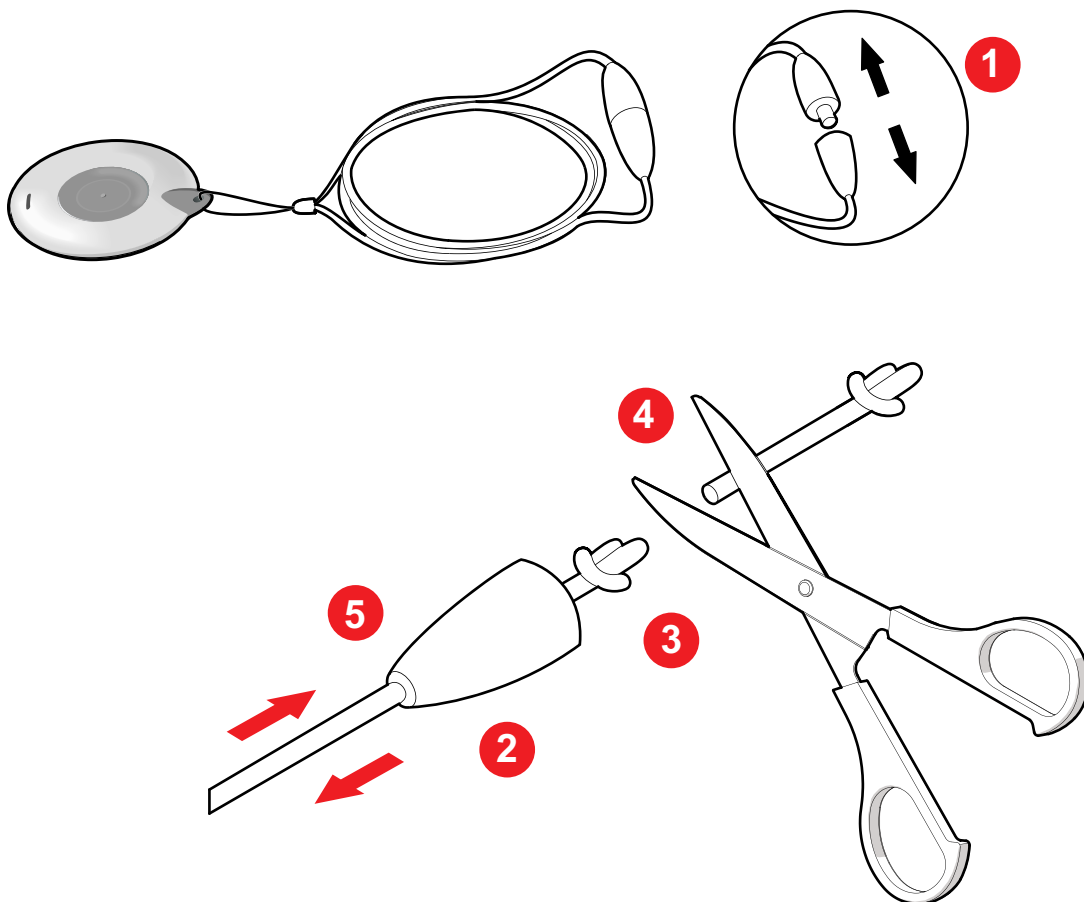

7.4 Wireless detectors

Up to 20 wireless transmitters can be registered to your TA74. In order to work correctly, they must be paired to your device.

For more information, see the *Reference Manual*.

8 Operation

8.1 Emergency call to an alarm receiving centre

How the emergency call is processed at the alarm receiving centre

1. Initiate an emergency call with the TA74 or the wireless transmitter.
2. The emergency call is sent.
3. An operator at the alarm receiving centre takes your call.
4. Speak to the operator.
5. Wait until assistance arrives.

8.2 Emergency call to a landline telephone

The TA74 can be programmed to send an emergency call to a landline telephone or a cell phone via the public switched telephone network (PSTN). The emergency call from the TA74 is received just like a normal phone call.

How the emergency call is received on a landline telephone

1. Initiate an emergency call with the TA74 or the wireless transmitter.
2. The emergency call is sent.
3. The person picks up the phone.
4. The TA74 plays its announcement message, up to the number of times defined in the parameter **Number of announcements when calling a telephone**.
5. The called person must press the key **7** once to accept the call, at any time during the announcement message. Communication is then established in full duplex.



INFO

If key **7** is not pressed, the TA74 hangs up after reading its message. The call sequence is then continued.

6. Once the call has been accepted, the following functions are available (see table in section 8.4 "Key functions on a landline telephone or a VoIP phone", page 44).
7. The communication remains active for about three minutes. When this time has expired, a 3-beep tone is repeated at regular intervals to indicate that the call will now be terminated. To continue the call for another three minutes, press key **1** twice.
8. Press **0** twice to terminate the call.



NOTE

If the emergency call is not terminated by pressing **0** twice, the call will not be properly acknowledged. The TA74 will automatically dial the next call number.



INFO

Instead of the subscriber number, a personal message can be recorded, e.g. <This is Mrs. Brown's emergency call unit...>. For more information, see the *Reference Manual*.

8.3 Emergency call to a VoIP phone

The TA74 can be programmed to send an emergency call to a VoIP phone. The emergency call from the TA74 is received as explained in section 8.2 "Emergency call to a landline telephone", except for the following differences:

- Immediate full duplex when the person picks up the phone
- No announcement message
- No need to press **7** to take the call

8.4 Key functions on a landline telephone or a VoIP phone

If the destination number is programmed with the telephone protocol or the VoIP protocol, the respective key function needs to be pressed twice in order to confirm the selection.

Key	Function
0+0	Terminate and acknowledge the call
1+1	Extend the call by another 3 minutes
2+2	Repeat the alarm message
3+3	Speak into the TA74 at normal audio volume
4+4	Listen to the TA74 announcement
5+5	Increase the audio volume and speak into the TA74
6+6	Reduce the audio volume and speak into the TA74
7+7	Interrupt all announcements played by the TA74 and switch to duplex mode (two-way operation)
8+8 + 0+0	Cancel the repeated call function for the call by pressing 8 twice and then 0 twice
9+9	Reject the call and terminate. The TA74 dials the next number on the list.
#+#	Activate the relay output for 10 seconds (TA74 IO, TA74 GSM IO and TA74 4G IO only) INFO: The parameter Activate output must be set to "Remote activation."

8.5 Taking phone calls



INFO

This function is only available with a PSTN and GSM connection.



INFO

This function is only available with a GSM connection:

- if the micro-SIM card is correctly inserted in the TA74,
- if the GSM module is configured (SIM card PIN code, provider APN, etc.).

The TA74 can be programmed in order to answer phone calls by pressing the **Emergency call button** on the device or using the wireless transmitter. To do this, make sure that parameter **Incoming call recognition** is not set to OFF. For more information, see the *Reference Manual*.

Taking phone calls with the TA74

1. To answer a phone call with the TA74, press the **Emergency call button** when the phone rings.
2. To terminate the call, press the **Emergency call button** again.

Taking phone calls with the wireless transmitter

1. To answer a phone call with the wireless transmitter, press the button of your wireless transmitter when the phone rings.
2. To terminate the call, press the button of your wireless transmitter again.

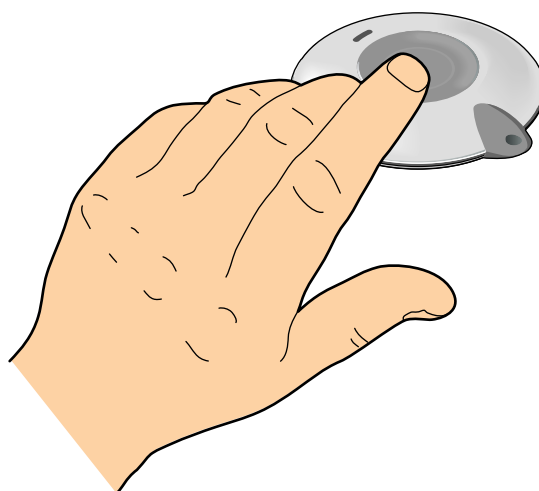

8.6 Test instructions

8.6.1 Manual test emergency calls

Make sure you perform a test regularly by sending a manual test emergency call with the wireless transmitter. This will test the wireless connection between the wireless transmitter and the TA74 and the connection between the TA74 and the alarm receiving centre.



WARNING!

Risk to the person in need of assistance as a result of failed emergency calls.
Test the emergency call function at least once a week.

Performing a test

Press the button on the wireless transmitter.

- ▶ The TA74 should call the alarm receiving centre or the landline phone.

8.6.2 Automatic test emergency calls

In addition to manual test emergency calls, the TA74 carries out automatic device tests to check the device functions. The device can be programmed to carry out an automatic test call.

The following test call intervals can be selected:

- 0 to 28 days in the case of connection via PSTN (analogue) or GSM (mobile network)
- 0 to 999 hours in the case of connection via Ethernet (LAN) or GRPS.



INFO

For use as a care aid in Germany, an automatic test call at intervals of seven days must be programmed.

8.6.3 Automated control functions

The TA74 is equipped with automated device control functions. These monitor and ensure that the installed batteries and connected wireless components are functioning correctly. They also monitor the transmission paths PSTN (analogue), LAN (Ethernet) and GSM (mobile network) installed for emergency calls. Error messages are announced on the device and, depending on the configuration, transmitted to the alarm receiver. For further information, see section 4.6.3 "Error messages", page 18.

In the factory setting, the following components are monitored:

Radio transmission monitoring

Radio transmission between the TA74 and all programmed wireless components is tested every 21 hours. If alarm receivers are configured, the error message and the re-establishment of radio transmission are transmitted automatically.

Battery charge in the wireless components

The battery charge of the wireless components is tested every 21 hours. If alarm receivers are configured, the error message is transmitted automatically.

Battery charge, TA74

The installed unit battery is tested every twelve hours (every two hours in the event of a power failure). If the battery charge is too low, an acoustic error message is output on the device. If alarm receivers are configured, the error message and the re-establishment of the battery charge are transmitted automatically.

Voltage monitoring

In the event of a voltage failure on the TA74, an acoustic error message is output on the device. If alarm receivers are configured, the error message and re-establishment of the mains voltage supply are transmitted automatically.

Performance monitoring

In the event of the failure of PSTN (analogue), Ethernet (LAN) and GSM (mobile network) transmission, an acoustic error message is output on the device. If alarm receivers are configured, the error message and re-establishment of the line are transmitted automatically. In the case of PSTN and Ethernet, this takes place after one minute, in the case of GSM after 60 minutes.

9 Cleaning, disinfection, maintenance, reuse

The installer should perform the following checks:

- Check the device housing for damage such as cracks or chipping.
- Test the buttons and check that the spaces between the buttons are clean.
- Check the cables regularly for damage.
- Check compliance with safety instructions (see chapter 1 "Safety").

9.1 Cleaning and disinfection

Clean the TA74 and the wireless transmitter with a soft, dry cloth or soft brush.

Remove stubborn dirt with a damp but not wet cloth and a pH-neutral cleaning agent.

To disinfect the TA74 and the wireless transmitter by wiping, TeleAlarm recommends an alcohol-free disinfectant with proven effectiveness (as listed by the Association for Applied Hygiene – VAH), e.g. Incidin®.

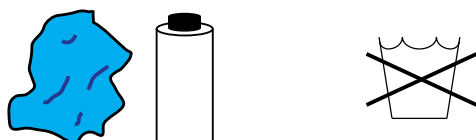

NOTE

Do not use abrasive, aggressive or corrosive cleaning agents. These will damage the TA74 and the wireless transmitter. Make sure that no electrical contacts come into contact with moisture during cleaning.

Do not spray cleaning agents or disinfectants directly onto the TA74.



If a liquid is spilled into the loudspeaker holes or the buttons of the TA74, simply hold the device upside down to remove the liquid from the device. Gently shake the device if necessary. Perform a test to check proper speech function (see section 8.6 "Test instructions").

9.2 Maintenance

A technician must perform maintenance each time there is a change of user. In order for the TA74 to offer maximum safety over its entire service life, maintenance must be carried out at least every five years without user changes.

1. Replace the unit battery of the TA74 after five years at the latest, see section 9.5 *"Replacing the unit battery"*. TeleAlarm recommends replacing the battery with a replacement battery from TeleAlarm after only three years (order number T.200.001.296).
2. Replace the wireless transmitter battery after five years at the latest, see section 9.6 *"Replacing the battery of the wireless transmitter"*.
3. Disinfect and clean the TA74 and wireless transmitter, see section 9.1 *"Cleaning and disinfection"*.
4. Check the housing of the TA74 and the wireless transmitter for mechanical damage. Damaged housings can be replaced by TeleAlarm or independently.
5. Check connecting cables for damage and loose contacts. Replace defective connecting cables with original TeleAlarm cables.
6. Carry out a function test. For this purpose, a test emergency call should be triggered via the emergency call button and the wireless transmitter, see section 8.6 *"Test instructions"*.

If the responsible technician is not able to carry out the maintenance on the devices completely and the devices are not in perfect condition, have them checked and serviced by TeleAlarm.

9.3 Reuse

The TA74 and the wireless transmitter are suitable for reuse by other users. Authorised personnel must prepare the device and the wireless transmitter for reuse as follows:

1. Deinstallation: Disconnect all plugs from the device. Begin with the power supply.
2. Disinfect, clean and carry out maintenance on the devices, see section 9.1 *"Cleaning and disinfection"* and section 9.2 *"Maintenance"*.
3. Disinfect the TA74 and wireless transmitter again before packing.
4. If necessary, have devices checked and serviced by TeleAlarm.
5. Replace missing accessories and Quick Guide, see chapter 3 *"Scope of delivery"*.
6. Program the TA74 and wireless transmitter for the new user.

9.4 Disposing of the device

Electrical or electronic devices that are no longer serviceable must be collected separately and sent for environmentally compatible recycling (in accordance with the European Directive on Waste Electrical and Electronic Equipment). To dispose of old electrical or electronic devices, you should use the return and collection systems established in the country concerned. Old unit batteries should be disposed of in the same manner.



9.5 Replacing the unit battery

The unit battery of the TA74 has a limited lifetime and should be replaced after three years, or if the device announces the error <Unit battery empty>. Replace the battery even if the device is continually connected to the main power supply.

**NOTE**

The TA74 should be serviced by trained and authorised personnel only.

**NOTE**

Use only original batteries made for the corresponding device and supplied by TeleAlarm. Any other batteries could damage the device.

To replace the battery:

1. Disconnect all plugs from the device. Begin with the power supply.

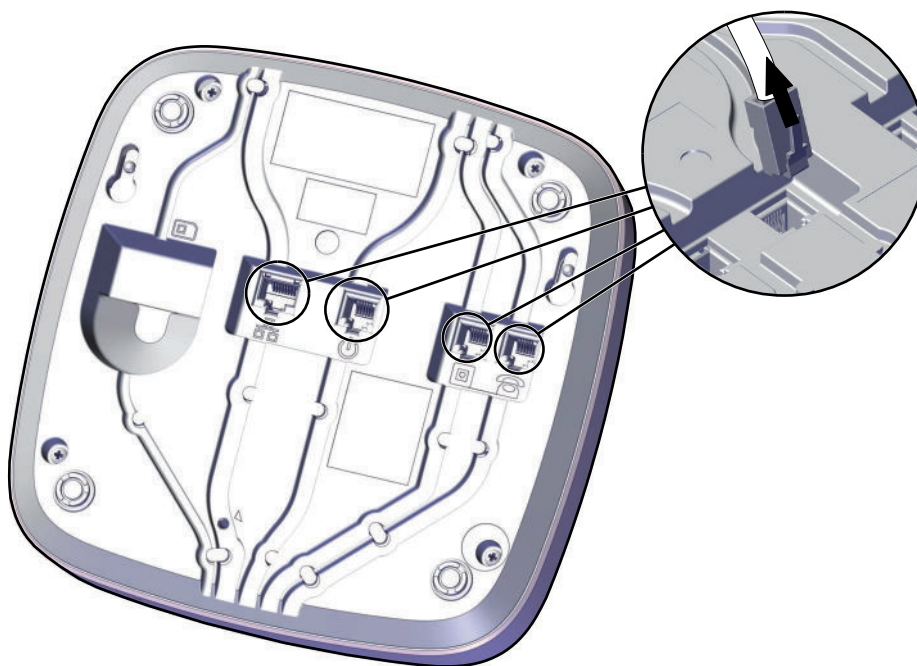

2. Unscrew the four screws on the bottom of the device and remove the lower cover.

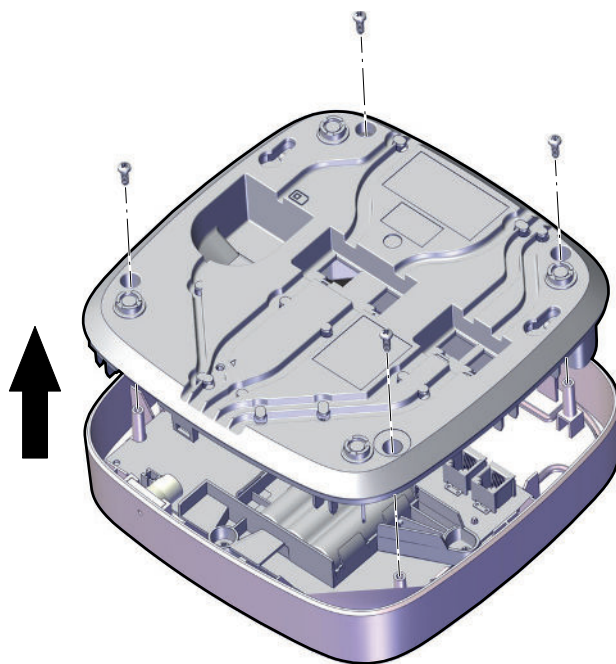

3. Disconnect the plug of the unit battery from the device.
4. Lever off the battery with a screwdriver and release it from the two braces. Pull it out gently.

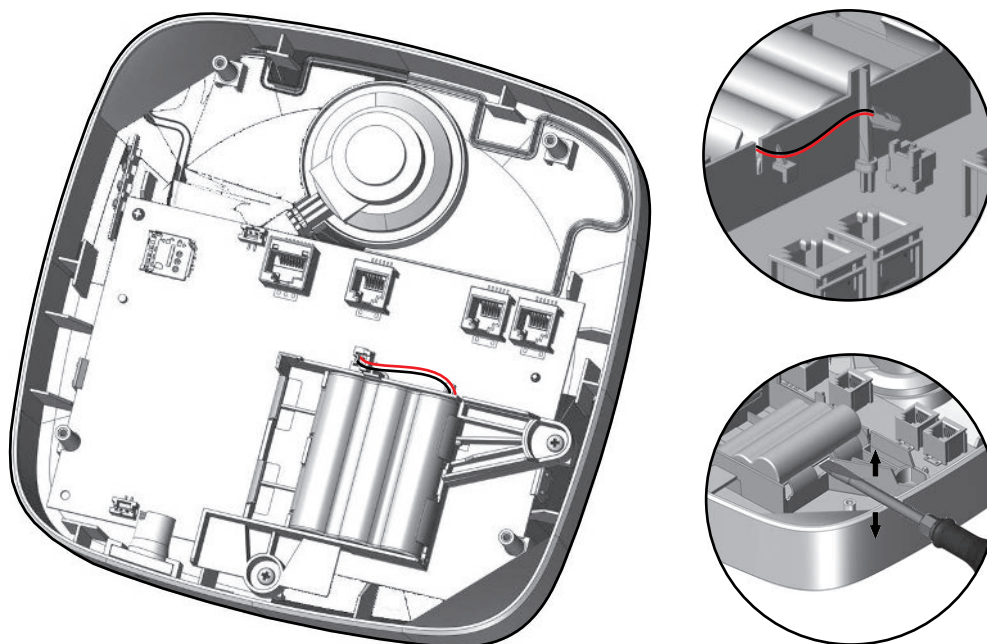

5. Insert the new battery by guiding it under one of the two braces.
6. Then push the side of the new battery over the other brace until it is clamped.
7. Connect the plug of the unit battery to the device.

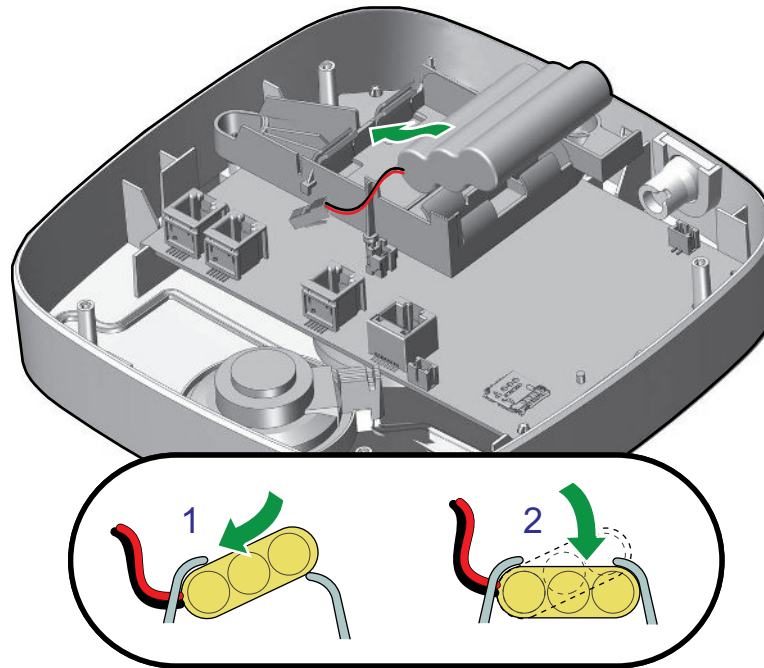

8. Place the cover back on the device and screw in the four screws.

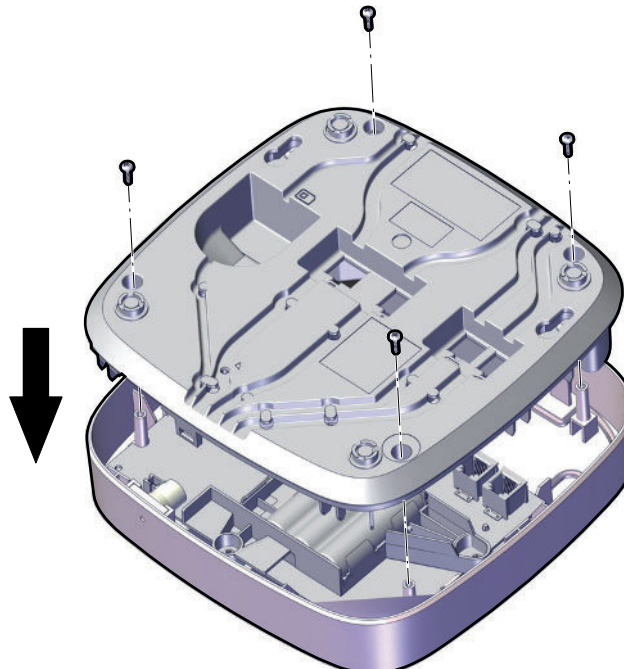

9. Connect all plugs to the device as described in *section 5.3 "Connecting the TA74"*.
10. Perform a test as described in *section 8.6 "Test instructions"*.
11. Dispose of the old battery as described in *section 9.4 "Disposing of the device"*.

9.6 Replacing the battery of the wireless transmitter

The battery of the wireless transmitter should be replaced when the integrated LED flashes three times when the button is pressed.



NOTE

The wireless transmitter should be serviced by trained and authorised personnel only.

To replace the battery:

1. Open the wireless transmitter using the dedicated tool.

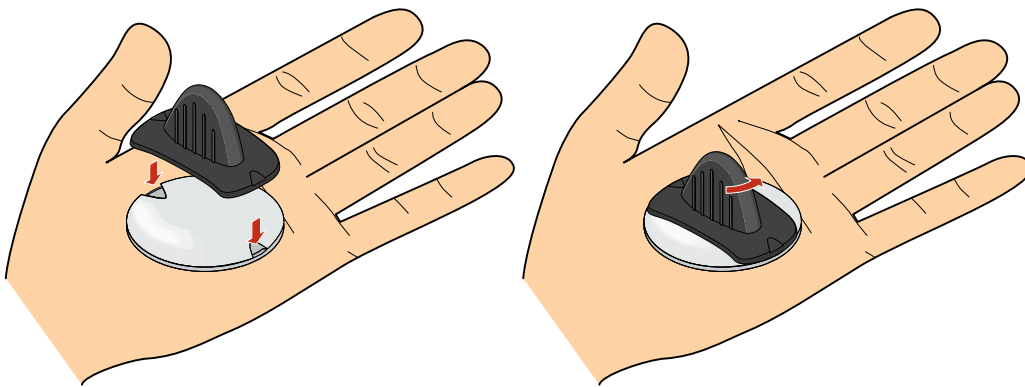

2. Remove the old battery.
3. Insert the new battery (CR2430).

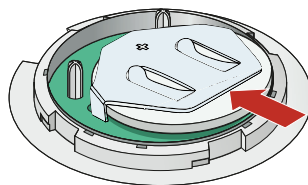

4. Carefully close the wireless transmitter using the dedicated tool.
5. Perform a test as described in *section 8.6 "Test instructions"*.
6. Dispose of the old battery as described in *section 9.4 "Disposing of the device"*.

WARNING!



If swallowed, button cell batteries can cause severe internal burns and fatal injury. Keep new and used batteries out of the reach of children.

If the battery compartment does not close securely, stop using the product and keep it out of the reach of children. If a battery has been swallowed or is inside any part of the body, seek immediate medical attention.

10 Appendix

10.1 TA74 technical specifications

Dimensions (H x W x D)	50 x 191 x 191 mm
Weight	Approx. 0.6 kg
Permissible temperature range	<ul style="list-style-type: none"> – Operation: +5 °C to +40 °C – Storage: –20 °C to +60 °C
Maximum relative humidity	93 %
Altitude	Up to 5000 m
Switched-mode power supply	AC Adapter 100 – 240 V AC, 50/60 Hz, 0.4 A (input), 6.1 V DC, 1.6 A (output)
Unit battery	3.6 V NiMH battery, 2.2 Ah
Battery operating time	<p>TA74, TA74 IO: min. 48 h with one 30-minute call.</p> <p>TA74 4G, TA74 4G T ,TA74 4G IO: min. 36 h with one 30-minute call.</p> <p>All values on date of purchase with a fully charged battery.</p>
Current consumption	<ul style="list-style-type: none"> – Approx. 160 mA in standby with mains power supply – Approx. 35 mA in standby with battery operation
Communication connections	<p>All devices: Ethernet/VoIP.</p> <p>TA74, TA74 IO, TA74 4G T: PSTN.</p> <p>TA74 4G, TA74 4G T, TA74 4G IO: GSM/GPRS/UMTS/LTE/ VoLTE.</p>
Frequency	869.2125 MHz
RF receiver	Complies with category 1 as specified by EN 300220-1 V3.1.1
Degree of protection*	IP32 (IP30 for wall mounting) in accordance with IEC 60529
Environmental class	Class 1 as specified by EN 50134-3
Max. number of wireless transmitters and detectors	20
Emergency call protocols	Multi-protocol (EN 50134-9, RBIP-S, SCAIP, RBIP, SIP, telephone, RB2000, RB2000E, TTnew+, CPC, BS8521)
Programmable call numbers	10 call destinations freely assignable to any type of trigger group
Volume settings	8 levels
Voice message	Recordable, max. 10 seconds
Hands-free range	Min. 15 m
Self-test function/test call	<p>Analog protocols: Freely selectable from 1 to 28 days.</p> <p>IP protocol: Freely selectable from 1 to 999 hours</p>
Available languages	Dutch, English, French, German, Spanish, and tone only
User guidance	Synthetic speech and LED indication
User assistant	"Synthetic speech disabled" mode

Programming options	<ul style="list-style-type: none"> – LAN using the Configuration Manager software – Remote programming via the TeleAlarm® Cloud Services platform – Remote programming from an alarm receiving centre – Service mode
Connectivity	<ul style="list-style-type: none"> – Ethernet/LAN (10/100 MB/s) – Phone line (PSTN) (not available on the TA74 4G and the TA74 4G IO) – External telephone (not available on the TA74 4G) – Micro-SIM card socket (TA74 4G, TA74 4G T and TA74 4G IO) – Internal input/output (TA74 IO and TA74 4G IO only)
SIM card size	Micro-SIM (15 mm x 12 mm)
Mobile network	2G GSM: GSM900, DCS1800 3G UMTS: B1, B8 4G LTE: B1, B3, B7, B8, B20, B28
Vocal reminders	Three recordable reminder messages (max15 sec.) (programming of day/time of playback)

*) The first digit of the degree of protection IP32 or IP30 has the following meaning:

3 means protection against solid foreign objects with a diameter of ≥ 2.5 mm and against access with a tool. The second digit has the following meaning: **2** means protection against dripping water if the housing is inclined up to 15° . **0** means no protection against water.

10.2 Technical specifications of wireless transmitter

Dimensions (H x D)	11 x 41 mm
Weight	15 g
Permissible temperature range	<ul style="list-style-type: none"> – Operation: –10 °C to +55 °C – Storage: –20 °C to +80 °C
Electrical power supply	Replaceable lithium battery CR2430
Current consumption	<ul style="list-style-type: none"> – Transmission power: max. 22 mA – Quiescent mode: max. 3 µA
Battery lifetime	Approx. 5 years if one emergency call is triggered per day. The device automatically monitors the radio link and battery every 21 hours
Frequency	869.2125 MHz
Stability (0 °C to +55 °C)	< 2.5 kHz
Modulation	FSK
Antenna	Integrated
Radiated intensity	Approx. 320 µW
Degree of protection*	IP67 in accordance with IEC 60529
Environmental class	II
Maximum range	<ul style="list-style-type: none"> – Inside buildings: 30 – 50 m (depending on the building structure) – In the open air: max. 300 m

*) The first digit of the degree of protection IP67 has the following meaning: **6** means dust-tight. The second digit has the following meaning: **7** means protection against submersion for up to 30 minutes at a maximum depth of 1 metre.

10.3 Certifications and approvals

CE Directives	LVD 2014-35-EU, EMC 2014-30-EU, RED 2014/53/EU, RoHS 2011/65/EU
Standards complied with	<ul style="list-style-type: none"> – EN 50134-1 – EN 50134-2 – EN 50134-3 – EN 50134-5 – EN 301489-1 V2.1.1 – EN 301489-3 V1.6.1 – EN 62368-1 – EN 62479 – EN 50130-4 – EN 55032 – EN 301 511 V12.5.1 (for GSM module only) – EN 301 908-2 V11.1.1 (for GSM module only) – EN 301 489-7 V1.3.1 (for GSM module only) – EN 301 489-24 V1.5.1 (for GSM module only) – EN 300220-2 V3.1.1 (Category 1 radio receiver)

10.4 Licences

The TA74 firmware contains a library, called lwIP, which is licensed under the BSD licence: Copyright © 2001-2004 Swedish Institute of Computer Science. All rights reserved.

Redistribution and use of the lwIP library in source and binary forms, with or without modification, are permitted provided that the following conditions are met:

1. Redistributions of source code must retain the above copyright notice, this list of conditions and the following disclaimer.
2. Redistributions in binary form must retain the above copyright notice, this list of conditions and the following disclaimer in the documentation and/or other materials provided with the lwIP library.
3. The name of the author may not be used to endorse or promote products derived from this software without specific prior written permission.

This software is provided by the author "as is" and any express or implied warranties, including, but not limited to, the implied warranties of merchantability and fitness for a particular purpose are disclaimed. In no event shall the author be liable for any direct, indirect, incidental, special, exemplary, or consequential damages (including, but not limited to, procurement of substitute goods or services; loss of use, data, or profits; or business interruption) however caused and on any theory of liability, whether in contract, strict liability, or tort (including negligence or otherwise) arising in any way out of the use of this software, even if advised of the possibility of such damage.

10.5 Conformity

All connected parts must meet the electrical insulation requirements of TNV3, EN 60950.

The TA74 is designed for operation on the public analogue telephone network, Ethernet or GSM network. The wireless transmitter that is supplied with the device uses the frequency specially reserved for emergency calls in Europe.

We, TeleAlarm®, declare that the above-mentioned products are manufactured in compliance with EU Directives LVD 2014/35/EU, EMC 2014/30/EU, RED 2014/53/EU and RoHS 2011/65/EU.

TeleAlarm SA
Rue du Pont 23
2300 La Chaux-de-Fonds
Switzerland
www.telealarm.com

© Copyright TeleAlarm SA, 2023

TeleAlarm Europe GmbH
Hertzstraße 2
04329 Leipzig
Germany

Contact in UK
Tel: +44 (0) 333 0124392
info-uk@telealarm.com